

Tulla Comfort Height Rimless Open Back Close Coupled Skirted WC Suite INSTU001CSR, INSTU002, INSTU004



Cistern Specification

Close Coupled Dual Flush Cistern
(INSTU002)

Finish	White
Dimensions	400(h) x 355(w) x 142(d) mm
Weight	14.5kg
Cistern Fitting Manufacturer	R&T
Lever	Push Button
Lever Position	Cistern Lid
Inlet Position (When looking at WC)	Right Hand

Seat Specification

Duraplast Quick Release, Soft Close, Seat + Cover
(INSTU004)

Finish	White
Dimensions	40(h) x 362(w) x 435(d) mm
Weight	1.74kg
Seat Hinge Material	Metal / Plastic
Antibacterial Protection	Yes
Seat Type	Standard
UV Protection	Yes
Max Load Test	150kg
Seat Material	Duraplast

Pan Specification







Comfort Height Rimless Open Back Close Coupled Skirted Pan
(INSTU001CSR)

Finish	White
Dimensions	450(h) x 360(w) x 630(d) mm
Weight	25kg
Fixing Supplied	Yes
Fixing Exposed or Concealed	Concealed

FAQs

Please see next page

Key Features + Benefits

25 Years Guarantee on Ceramics	1 Years Guarantee on Seats	3 Years Guarantee on Cistern Components	 Open Back WC Suite	 Close Coupled WC Suite	 Comfort Height Pan	 Rimless Pan	 6 Ltr / 4 Ltr Dual Flush Volume	 4 Ltr / 2.6 Ltr Eco Dual Flush Volume	 Soft Close Seat
--	--------------------------------------	---	---	---	---	--	--	--	--

Certifications + Approvals

Imex Ceramics

15 Millbrook Industrial Estate, Sybron Way, Crowborough TN6 3DU. Technical Support – Tel: 01530 835598 Email: sales@imexceramic.co.uk

All information on the data sheet is correct at the time of publication. All measurements are approximate and subject to standard tolerances.

Tulla Comfort Height Rimless Open Back Close Coupled Skirted WC Suite INSTU001CSR, INSTU002, INSTU004

Pan (INSTU001CSR) + Cistern (INSTU002)

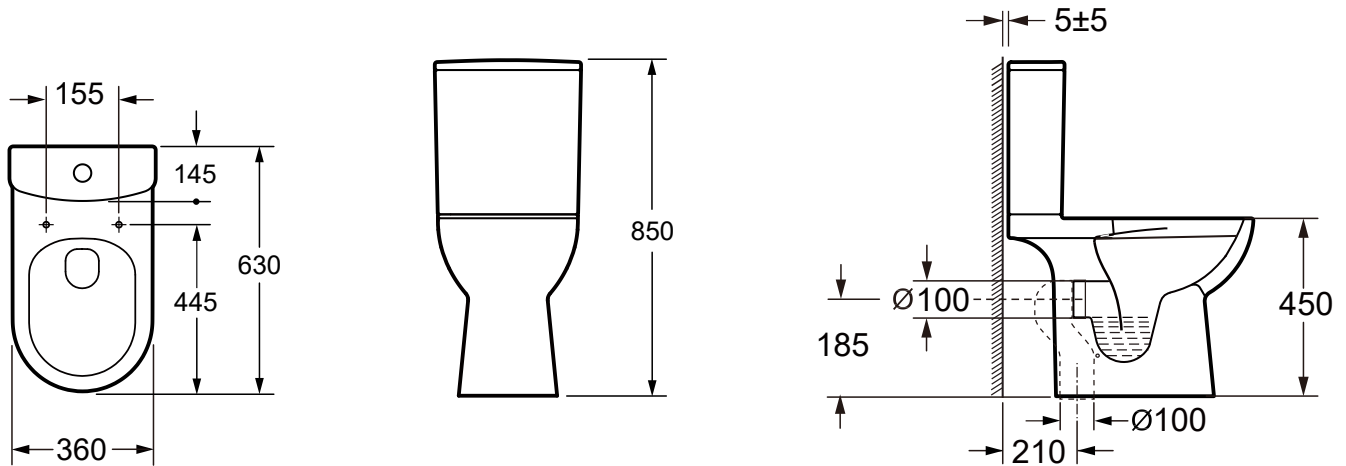

Extra Dimensions

Left to Right Footprint – 360mm
 Pan Height (+Cistern) – 450mm (850mm)
 Pan Overall Front to Back – 630mm
 Centre Waste Outlet to Floor – 185mm

Seat (INSTU004)

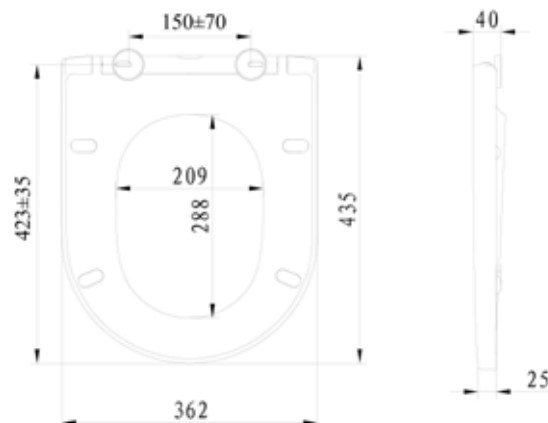

Extra Dimensions

Seat/Lid Front to Back – 435mm
 Seat/Lid Left to Right – 362mm
 Ring Hole Front to Back – 288mm
 Ring Hole Left to Right – 209mm

Imex Ceramics

15 Millbrook Industrial Estate, Sybron Way, Crowborough TN6 3DU. Technical Support – Tel: 01530 835598 Email: sales@imexceramic.co.uk

All information on the data sheet is correct at the time of publication. All measurements are approximate and subject to standard tolerances.

Tulla Comfort Height Rimless Open Back Close Coupled Skirted WC Suite INSTU001CSR, INSTU002, INSTU004

FAQs

Q – What is the flush volume?

A – 6/4L. Eco flush 4/2.6L.

Q – Is this pan rimless or box rim?

A – Rimless.

Q – What finish is the ceramic glaze?

A – White.

Q – What finish is the flush button supplied with the cistern?

A – Chrome.

Q – Can the flush button be upgraded to a different finish?

A – Yes using INSFMBB (black) or INSFBBB (brushed brass).

Q – Does it have an airgap?

A – Yes.

Q – What's the maximum test load of the seat?

A – 1.50kg.