

Zen Series

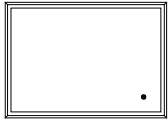

Frame Series

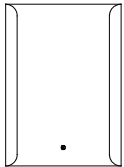

Cruise Live Series

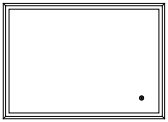

Fuse Frame Black Series

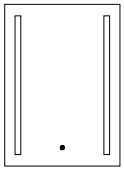

Zest Series

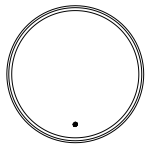

Fuse Frame Black Round 700

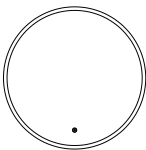

Linea Plus Round Series

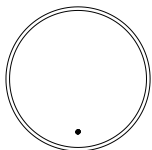

Linea Live Plus Round Series

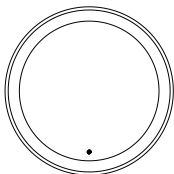

Saturn Series

Please read these instructions carefully before installation.  
Installation should be carried out by a qualified electrician.

**GENERAL**

- THIS PRODUCT CONFORMS TO UK SAFETY STANDARDS AND MUST BE INSTALLED IN ACCORDANCE WITH CURRENT IEE WIRING REGULATIONS AND BUILDING REGULATIONS (PART P). THIS PRODUCT MUST BE EARTHED, AND SHOULD NOT BE CONNECTED TO AN UNEARTHED CIRCUIT.
- ENSURE THAT CONNECTIONS ARE TURNED OFF AT THE CONSUMER UNIT OR FUSE BOARD BEFORE INSTALLING OR CARRYING OUT ANY MAINTENANCE.
- THIS PRODUCT IS FOR IN DOOR USE ONLY.
- THIS PRODUCT IS IP44 RATED AND CAN BE INSTALLED IN BATHROOM ZONE 2 (AS DEFINED BY THE IEE WIRING REGULATIONS) AND BEYOND. SEE BATHROOM DIAGRAM BELOW.
- REPLACE FAILED LAMPS IMMEDIATELY. ALLOW THE GLASS, LAMP AND FITTING TO COOL BEFORE REPLACING THE LAMP.

IEE Bathroom Zones Diagram

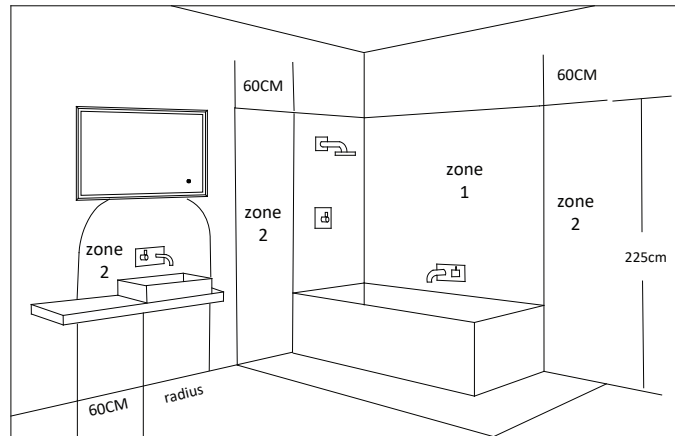

OUTSIDE ZONES

**IMPORTANT**

- When working at heights, please use a suitable platform to work from.
  - Please note: For new installations, check for any electrical cables or pipe work (gas/water) in the vicinity of the intended mounting point before proceeding with the installation.
- Ensure that the fixing location is able to take the weight of the complete fitting.  
Wear suitable eye protection when drilling. Be careful when using power tools near water.

Do NOT strike mirror glass with hard or pointed items. It is recommended that the product is cleaned with a soft, dry, non abrasive cloth. Do NOT use cleaning agents or abrasive materials on any type of finished surface. Do NOT allow moisture to come into contact with the electrical components.

**Compliance**

This product complies with the following safety standards:  
BS EN 60598-1: 2008+A11: 2009, EN60598-2-1: 1989

**Wiring**

This product is manufactured to class I category and requires an earth connection

**COLOUR CODING:**

- L - Live = Brown
- Neutral = Blue
- ⊕ - Earth = Green & Yellow

## Installation procedure

1. Open the carton and make sure all the parts listed below are present

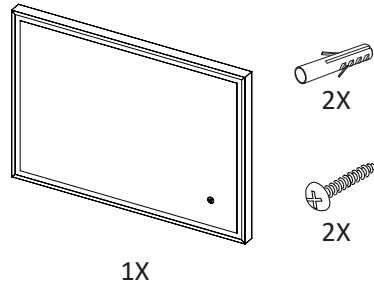

2. Mark a desired height of the mirror. Drill the required holes and insert the wall plugs.  
 Note: Wall plugs supplied are only suitable for solid stone/brick walls. Please ensure the screws are fully tight. The mirror can be mounted either portrait or landscape. Depending on the preferred mounting orientation of the mirror the IR sensor switch will be in a different position.

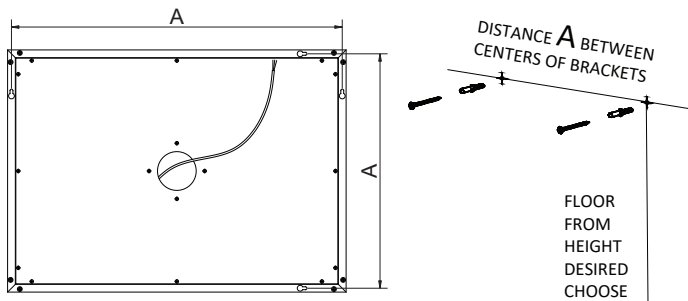

3. Make the electrical connections ensuring first that the electrical supply has been turned off. This mirror is a class 1 product and requires an earth connection. It should be installed in accordance with the latest IEE regulations.

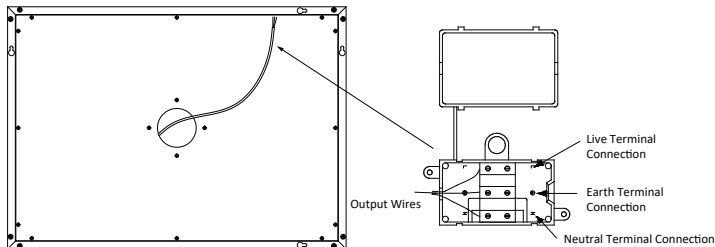

4. Hang the mirror onto the wall.

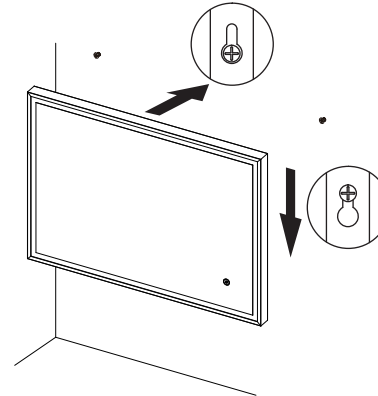

5. Press the icon to control on/off the lighting.

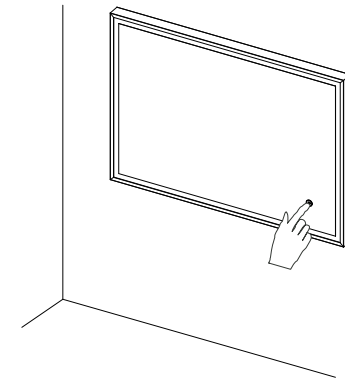

6. Bluetooth® wireless technology enabled device operation

<p>1. Cruise Live 75 Cruise Live 86</p> <p>To activate the Bluetooth®, operate the touch switch. The mirror will give out a tone to confirm it is ready for pairing.</p>	<p>2.</p> <p>Activate the Bluetooth® on your device*</p>	<p>3.</p> <p>Search for "Aqualla". The mirror will give out a tone to confirm successful connection.</p>	<p>4.</p> <p>You can now listen to your favorite song or on line radio station via the stereo speakers</p>
--	--	--	--

- When the mirror is turned off the connection to the Bluetooth® will be lost. When the mirror is turned on again it will automatically reconnect to the last connected device.

- Refer to your device manual for operating controls.

- Music will stop playing when a phone call comes into the Bluetooth® device, and will automatically reconnect when finished.

### Trouble Shooting Guide

symptoms	possible problem	solution
Device not paired	Bluetooth® not activated	Check Bluetooth® is activated on compatible device & mirror is turned on
Device not connecting	Only one device can be connected to the mirror at any one time	Disconnect all devices and reconnect only one device
No volume	Volume is controlled from device	Increase volume on device
No connection	Out of range	Range is within 8 metres, move device closer to mirror



Waste Electrical & Electronic Equipment Regulations (WEEE) requires that any of our products showing this mark (left) must not be disposed of with other household or commercial waste. To prevent possible harm to the environment or human health from uncontrolled waste disposal, please separate any such product from other waste types and recycle it responsibly at your local facilities. Check with your Local Authority, Recycling Center or retailer for recycling advice.