

### Shibden 1800 x 700mm Single Ended Bath INSSH18070SEW

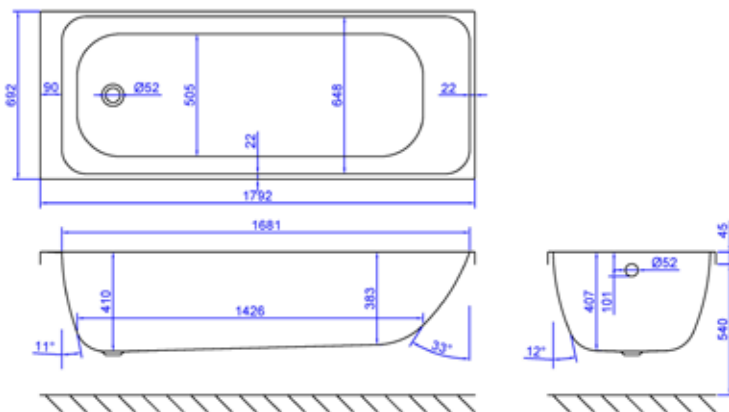

#### Specification

Finish	White
Dimensions	540(h) x 1792(w) x 692(d) mm
Weight	25.5kg
Bath Type	Back to wall
Tapholes	Can be drilled
Water Capacity	255 Litres
Legs Supplied	Yes
Leg Fixing Type	Cradle & Wall Supports
Legs Adjustable	Yes
Bath Surface Material	Acrylic
Bath Surface Material Thickness	5mm Acrylic + GRP
Waste Supplied	No
Waste Integrated	No
Click Waste Finish	-
Overflow Bath Filler Can Be Fitted	Yes
Overflow Type	Standard 52mm Drilling
Overflow Height	465mm
Encapsulated Base Board	Yes
Base Board Material	Wood
Material Used to Cover Base Board	Glass fibre resin
Weight of Material used to cover base board	16kg
Bath Frame	Yes
Bath Frame Material	Wood



#### Key Features + Benefits



#### Certifications + Accreditations



#### Carron Bathrooms Ltd

North Carron Works, Stenhouse Rd, Falkirk FK2 8UW, Scotland, United Kingdom. Technical Support – Tel: +44 (0)1324 638 407 Email: info@carronbathrooms.com

All information on the data sheet is correct at the time of publication. All measurements are approximate and subject to standard tolerances.