

### Nuance 700 x 800mm LED Illuminated Mirror INSNU800BB

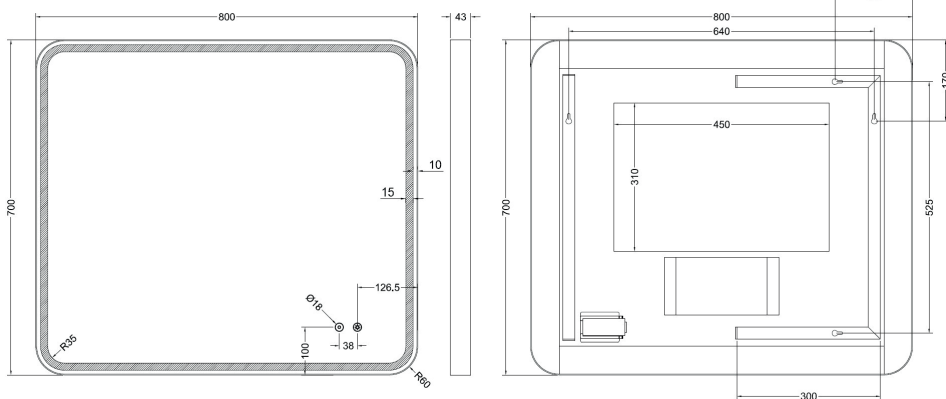

#### Specification

Finish	Brushed Brass
Dimensions	700(h) x 800(w) x 43(d) mm
Weight	9.5kg
Lighting Type	LED
Colour Changing Technology (CCT)	Yes
Switch Location	Front – touch sensor
Surface/Recess Fitting	Surface
Carcass/Frame Construction Material	Aluminium rear frame
Carcass/Frame Finish	Brushed Brass
Glass Thickness	5mm



#### Key Features + Benefits

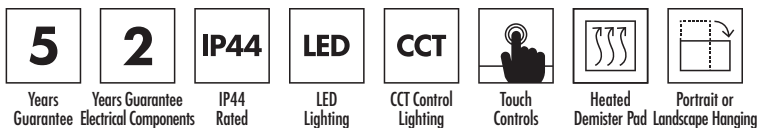

#### Certifications + Approvals

#### Aqualla Brassware

Unit 3 & 4 16 Crawfordsburn Road Newtownards County Down BT23 4EA. Technical Support – Tel: +44 (0) 28 9182 8000 Email: support@aquallabrassware.com

All information on the data sheet is correct at the time of publication. All measurements are approximate and subject to standard tolerances.