

### Nawton 1700 x 800mm Freestanding Bath INSNA17DEW

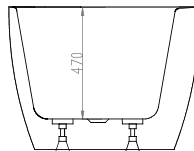

#### Specification

Finish	White
Dimensions	600(h) x 1700(w) x 800(d) mm
Weight	47kg
Bath Type	Freestanding
Tapholes	Can be drilled
Water Capacity	265 Litres
Legs Supplied	Yes
Leg Fixing Type	Pre-installed
Legs Adjustable	Yes
Bath Surface Material	Acrylic
Bath Surface Material Thickness	4mm Acrylic
Waste Supplied	Yes
Waste Integrated	Yes
Click Waste Finish	White
Overflow Bath Filler Can Be Fitted	No
Overflow Type	Integrated Slot
Overflow Height	75mm from top
Encapsulated Base Board	Yes
Base Board Material	HD Board
Material Used to Cover Base Board	Resin Fibreglass
Weight of Material used to cover base board	~4mm application of Resin Fibreglass
Bath Frame	No
Bath Frame Material	-

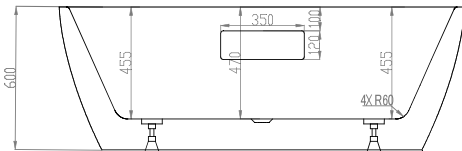
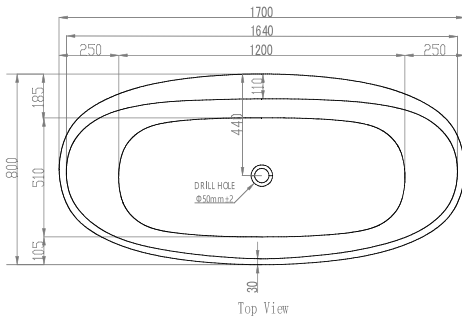

#### Key Features + Benefits



#### Certifications + Accreditations

#### Aqualla Brassware

Unit 3 & 4 16 Crawfordsburn Road Newtownards County Down BT23 4EA. Technical Support – Tel: +44 (0) 28 9182 8000 Email: support@aquallabrassware.com

All information on the data sheet is correct at the time of publication. All measurements are approximate and subject to standard tolerances.