

455mm

# Worktop Template

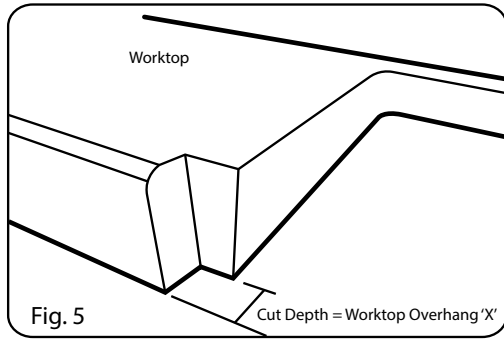
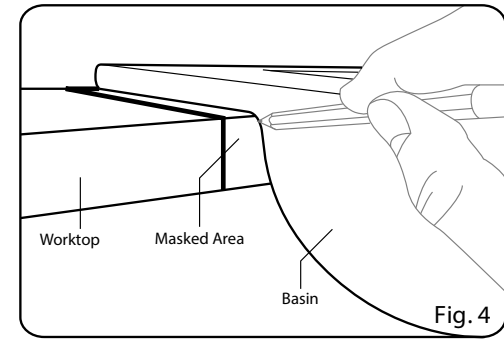
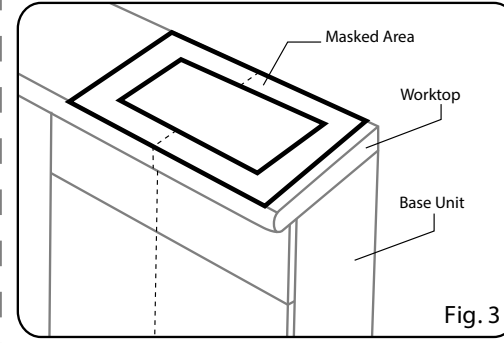
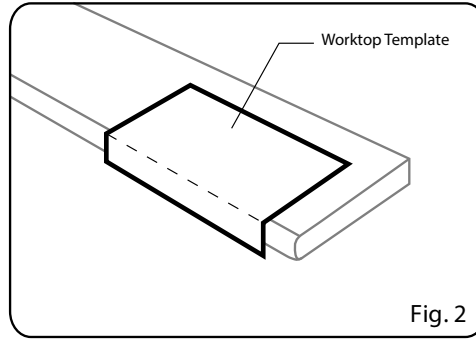
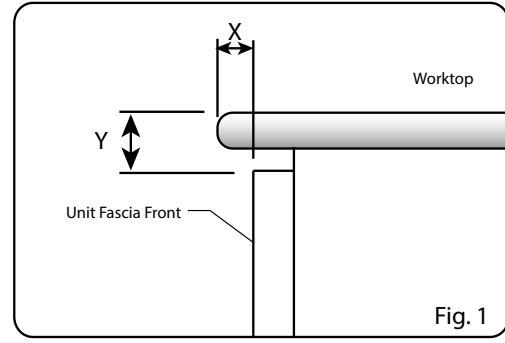

## Stage 1. Worktop Cutting Instructions

Before you begin, fit the worktop to the base unit.

1. Cut out the Worktop and Fascia templates along the outlines.
2. Measure the worktop overhang from the fascia front on the unit, 'distance X' (see Fig. 1)
3. Mark this distance on the Worktop Overhang area of the Worktop Template using the pre printed lines as a guide. Note, if you are using a Roper Rhodes laminate or solid surface worktop the overhang distance (12mm) has been pre marked. Mark the corresponding line and lightly score along it then fold.
4. Find the centre of the base unit the basin is to sit above. Using masking tape and a pencil, mark this position on the fascia just below the worktop.
5. Lay the cut out Worktop Template on the worktop aligning the centre line with the centre of the base unit (See Fig. 2).
6. Place masking tape beneath the template edges on the worktop (See Fig. 3). Then draw around the template outline onto the masking tape.
7. Detach the worktop from the unit and secure appropriately on a cutting bench before cutting inside the outline.
8. Drop the basin into the worktop and find its central position, then mark where the curved sides meet the worktop front (See Fig. 4).
9. Continue the basin outline on the top surface of the worktop by distance 'X' measured in step 2.
10. Cut the notch (See Fig. 5). Proceed to Stage 2. Fascia cutting instructions.

## Stage 3. Basin Fitting Instructions

Before you begin, it is recommended that you seal all the cut edges of the worktop and fascia with waterproof sealant (not supplied) to avoid water penetration and subsequent blowing.

1. Apply waterproof sealant (not supplied) to the rim of the basin and the area of the worktop where the two mate.
2. Place the basin (complete with tap and waste fittings) in position on the worktop and apply a firm pressure around all edges of the basin to achieve a good seal.
3. Remove excess sealant.
4. Allow the sealant to set for the recommended duration.

205mm

Unit Fascia Front

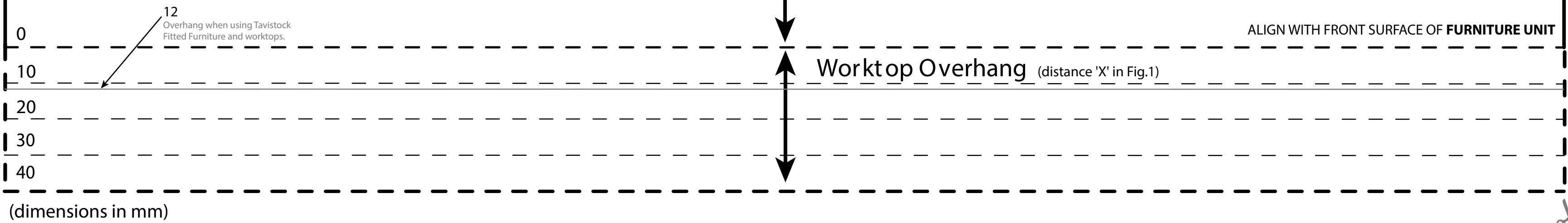

(dimensions in mm)

## Stage 2. Fascia Cutting Instructions

1. Cut out the Fascia template along the outer lines.
2. Measure the worktop thickness and, if necessary, also allow for the gap between top of the fascia and underside of worktop. This is measurement 'Y' (see Fig. 1 on main template).
3. Mark this total distance 'Y' on the Worktop Thickness area of the Fascia Template, starting from the top edge of the template. Use the pre printed lines as a guide. Mark the corresponding line with a straight edge, score and fold.
4. Find the centre of the fascia and using masking tape first, mark this position with a pencil.
5. Remove the fascia from the furniture unit. Lay the cut out Fascia Template on the fascia, aligning the centre line with the centre of the fascia. (See Fig. 6).
6. Place masking tape beneath the template edges on the fascia. Draw around the template outline onto the masking tape.
7. Double check all measurements and alignment before cutting! MAKE SURE WORKTOP THICKNESS IS ALLOWED FOR. Secure the fascia appropriately on a cutting bench before cutting inside the traced outline.
8. Re-attach the fascia to the base unit.

Worktop Thickness 'Y'  
REMEMBER TO ALLOW FOR GAP BETWEEN FASCIA AND UNDERSIDE OF WORKTOP

ALIGN WITH TOP SURFACE OF WORKTOP

## Fascia Template

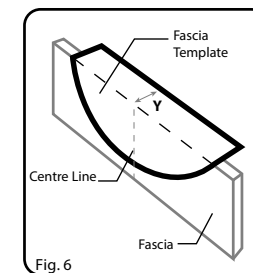

110mm

455mm