

Kinsley Standard Height Short Projection Rimless Closed Back Close Coupled WC Suite INST02020, INST02022, INST02028



Cistern Specification

Close Coupled Cistern
(INST02022)

Finish	White
Dimensions	465(h) x 360(w) x 145(d) mm
Weight	13.4kg
Cistern Fitting Manufacturer	R&T
Lever	Push button
Lever Position	Cistern lid
Inlet Position (When looking at WC)	Bottom right

Seat Specification

Quick Release, Soft Close, Seat & Cover
(INST02028)

Finish	White
Dimensions	49(h) x 363(w) x 425(d) mm
Weight	2.1 kg
Seat Hinge Material	Stainless Steel
Antibacterial Protection	No
Seat Type	Wrap Over
UV Protection	No
Max Load Test	150kg
Seat Material	Thermoset

Pan Specification

Standard Height Short Projection Rimless Closed Back
Close Coupled Pan
(INST02020)

Finish	White
Dimensions	420(h) x 360(w) x 620(d) mm
Weight	23.3kg
Fixing Supplied	Yes
Fixing Exposed or Concealed	Concealed







Spares

Please see next page

FAQs

Please see next page

Key Features + Benefits

10	5	2							
Years Guarantee on Ceramics	Years Guarantee on Seats	Years Guarantee on Cistern Components	Closed Back WC Suite	Close Coupled WC Suite	Short Projection Pan	Rimless Pan	Dual Flush Volume	Air Gap Inlet Valve	Soft Close Seat

Certifications + Approvals

Roper Rhodes

Brassmill Lane Trading Estate, Bath, BA1 3JF. Technical Support – Tel: 01225 303 900 Email: sales@roperrhodes.co.uk

All information on the data sheet is correct at the time of publication. All measurements are approximate and subject to standard tolerances.

Kinsley Standard Height Short Projection Rimless Closed Back Close Coupled WC Suite INST02020, INST02022, INST02028

Pan (INST01007) + Cistern (INST01002)

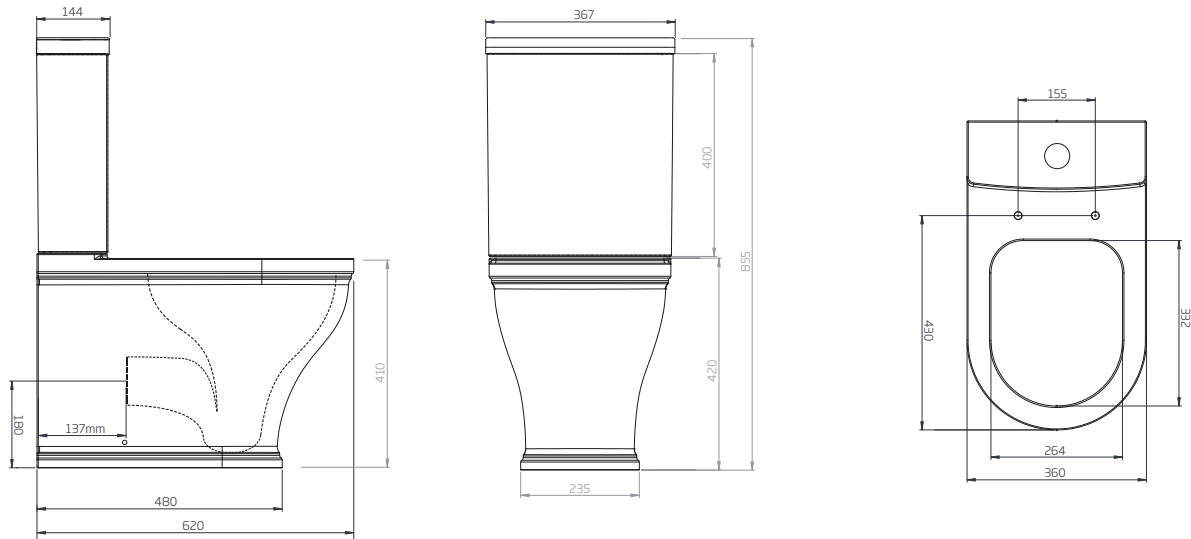

Extra Dimensions

Front to Back Footprint – 480mm
Left to Right Footprint – 235mm
Bowl Front to Back – 332mm
Bowl Left to Right – 264mm
Pan Height (+Cistern) – 420mm (855mm)

Pan Overall Front to Back – 620mm
Centre Waste Outlet to Floor – 180mm
Width of Void – 155mm
Is there a Ceramic Brace Bar – No
Distance from Spigot to back of Pan – 137mm

Seat (INST02028)

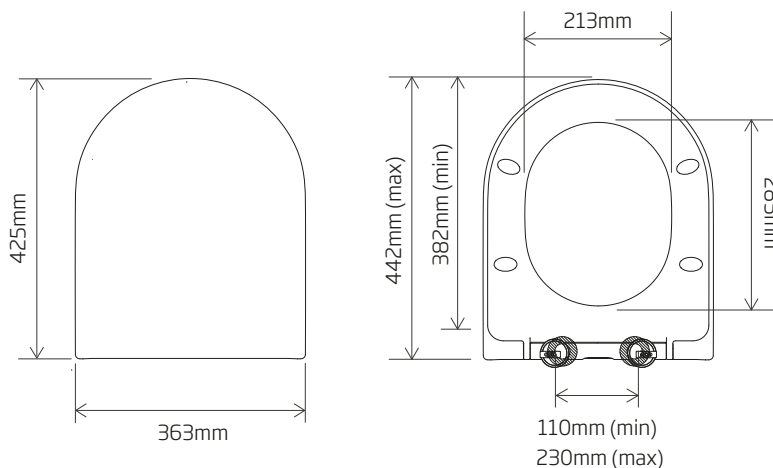

Extra Dimensions

Seat/Lid Front to Back – 425mm
Seat/Lid Left to Right – 363mm
Ring Hole Front to Back – 285mm
Ring Hole Left to Right – 213mm

Seat Overall Thickness – 49mm
Width of Back of Seat – 363mm

Spares

Floor Fixing Kit	SP11078
Flush Valve with Telescopic Overflow (A24232)	INST02043
Rubber Flap Seal (For A24232 Flush Valve)	SP19617
Air Gap Inlet Valve (Tall)	SP19528
Rubber Diaphragm (Air Gap Inlet Valve)	SP19616
Close Coupled Rubber Doughnut Washer	SP19538
Brass Tank Fixing Bolt Set (With M6*80mm Bolts)	SP19542
Chrome Flush Button (Ø38mm Hole)	SP19533
Black Flush Button (Ø38mm Hole)	INST02036
Brushed Brass Flush Button (Ø38mm Hole)	INST02044

Roper Rhodes

Brassmill Lane Trading Estate, Bath, BA1 3JF. Technical Support – Tel: 01225 303 900 Email: sales@roperrhodes.co.uk

All information on the data sheet is correct at the time of publication. All measurements are approximate and subject to standard tolerances.

Kinsley Standard Height Short Projection Rimless Closed Back Close Coupled WC Suite INST02020, INST02022, INST02028

FAQs

Q – What side is the inlet located?

A – Right hand side of cistern.

Q – Can this pan be used with a side connection outlet pipe?

A – No.

Q – What is the flush volume?

A – 6/4L.

Q – Is this WC rimless or box rim?

A – Rimless.

Q – Does it have an airgap?

A – Yes.

Q – Are there any other compatible seats?

A – No.

Q – What's the maximum test load of the seat?

A – 150kg.

Q – What are the fixings made from?

A – Stainless Steel Cover Plates/Screws, Nylon Anchor Plates, Rubber Washers, Rubber Fixing Plugs.