

Fuse Series

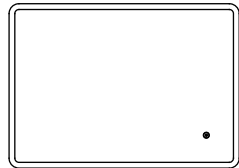

Linea Mood Plus Series

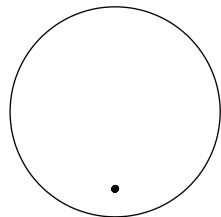

Fuse Round Series

Please read these instructions carefully before installation. Installation should be carried out by a qualified electrician.

### GENERAL

- THIS PRODUCT CONFORMS TO UK SAFETY STANDARDS AND MUST BE INSTALLED IN ACCORDANCE WITH CURRENT IEE WIRING REGULATIONS AND BUILDING REGULATIONS (PART P). THIS PRODUCT MUST BE EARTHED, AND SHOULD NOT BE CONNECTED TO AN UNEARTHED CIRCUIT.
- ENSURE THAT CONNECTIONS ARE TURNED OFF AT THE CONSUMER UNIT OR FUSE BOARD BEFORE INSTALLING OR CARRYING OUT ANY MAINTENANCE.
- THIS PRODUCT IS FOR IN DOOR USE ONLY.
- THIS PRODUCT IS IP44 RATED AND CAN BE INSTALLED IN BATHROOM ZONE 2 (AS DEFINED BY THE IEE WIRING REGULATIONS) AND BEYOND. SEE BATHROOM DIAGRAM BELOW.
- REPLACE FAILED LAMPS IMMEDIATELY. ALLOW THE GLASS, LAMP AND FITTING TO COOL BEFORE REPLACING THE LAMP.

IEE Bathroom Zones Diagram

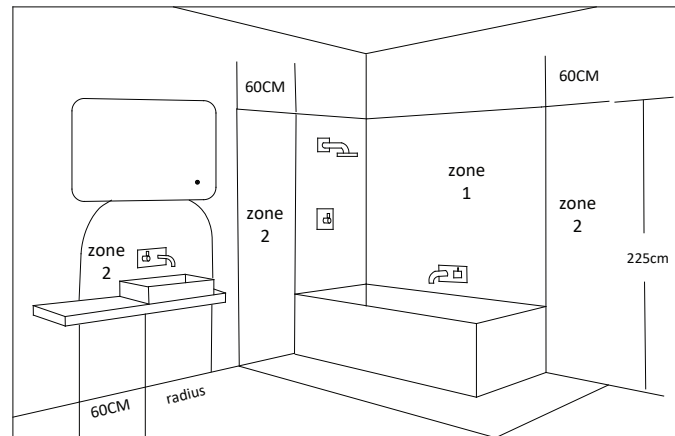

OUTSIDE ZONES

### IMPORTANT

- When working at heights, please use a suitable platform to work from.
- Please note: For new installations, check for any electrical cables or pipe work (gas/water) in the vicinity of the intended mounting point before proceeding with the installation.
- Ensure that the fixing location is able to take the weight of the complete fitting. Wear suitable eye protection when drilling. Be careful when using power tools near water.

Do NOT strike mirror glass with hard or pointed items. It is recommended that the product is cleaned with a soft, dry, non abrasive cloth. Do NOT use cleaning agents or abrasive materials on any type of finished surface. Do NOT allow moisture to come into contact with the electrical components.

### Compliance

This product complies with the following safety standards: BS EN 60598-1: 2008+A11: 2009, EN60598-2-1: 1989

### Wiring

This product is manufactured to class I category and requires an earth connection

### COLOUR CODING:

L - Live = Brown  
- Neutral = Blue

 - Earth = Green & Yellow

## Installation procedure

1. Open the carton and make sure all the parts listed below are present

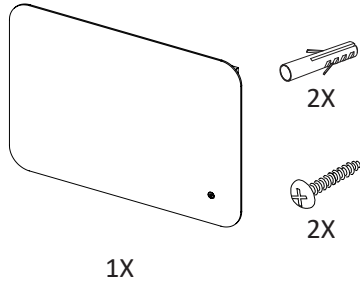

2. Mark a desired height of the mirror. Drill the required holes and insert the wall plugs.  
 Note: Wall plugs supplied are only suitable for solid stone/brick walls. Please ensure the screws are fully tight. The mirror can be mounted either portrait or landscape. Depending on the preferred mounting orientation of the mirror the IR sensor switch will be in a different position.

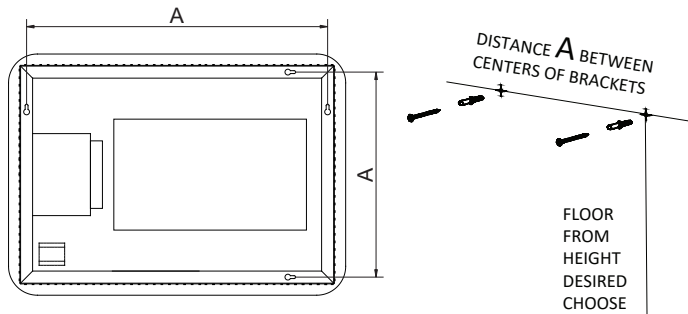

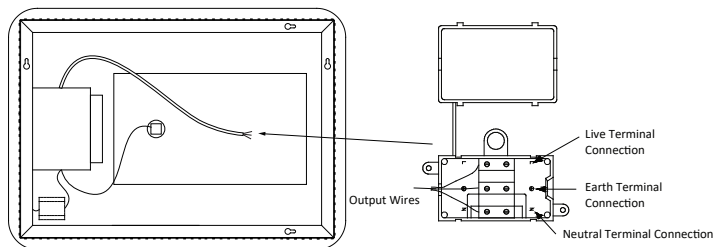

3. Make the electrical connections ensuring first that the electrical supply has been turned off. This mirror is a class 1 product and requires an earth connection. It should be installed in accordance with the latest IEE regulations.

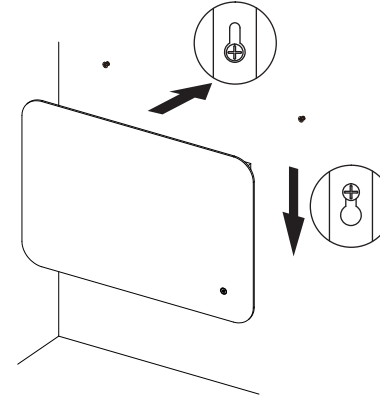

4. Hang the mirror onto the wall.



5. Press the icon shortly  to control on/off the lighting and heating pad. Press and hold the icon  to change the colour temperature.

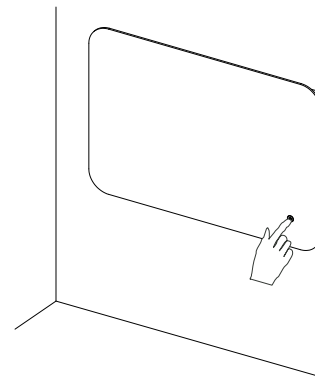

Waste Electrical & Electronic Equipment Regulations (WEEE) requires that any of our products showing this mark (left) must not be disposed of with other household or commercial waste. To prevent possible harm to the environment or human health from uncontrolled waste disposal, please separate any such product from other waste types and recycle it responsibly at your local facilities. Check with your Local Authority, Recycling Center or retailer for recycling advice.