

Hemsworth Bath Taps (Pair) 4E1071



Specification

Finish	Chrome
Dimensions	129(h) x 59(w) x 136(d) mm
Weight	1.181kg
Body	Brass
Spout Material	Brass
Fittings	Brass Backnut + Washer
Connection	¾" BSP Threaded Tail
Cartridge Size	½" NR Headwork
Flow Restrictor	No
Max Static Pressure	16 Bar
Min Operating Pressure	0.1 Bar
Max Operating Pressure	6 Bar
Max Water Temperature	85°C

Flow Rates

Pressure	0.2	0.5	1	3
Flow Aerator	-	-	-	-
Flow Straightener	31.1	53.4	77.8	139.0

All Pressures in Bar. All flow in L/Min. Dimensions supplied are nominal and subject to tolerance. Inclusion or restrictors (sold separately unless stated) will affect flow rate result. Performance details are based on trials under test conditions and for guidance only. The Company reserves the right to change product specification without prior notice.

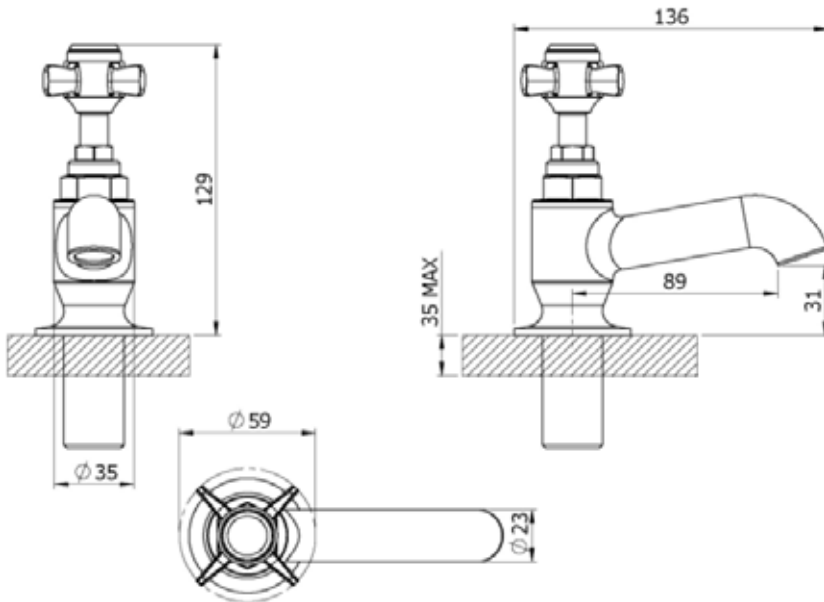

Key Features + Benefits

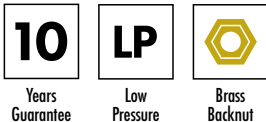

Certifications + Approvals

Flow Rate – 31.1 l/min

Tested at 0.2 Bar