

Espada Comfort Height Rimless Closed Back Close Coupled WC Suite INST01042, INST01009, INST01011



Cistern Specification

Close Coupled Cistern
(INST01009)

Finish	White
Dimensions	430(h) x 375(w) x 135(d) mm
Weight	14.3kg
Cistern Fitting Manufacturer	R&T
Lever	Push button
Lever Position	Cistern lid
Inlet Position (When looking at WC)	Bottom left

Seat Specification

Quick Release, Soft Close, Slim, Seat & Cover
(INST01011)

Finish	White
Dimensions	27(h) x 368(w) x 450(d) mm
Weight	3.1 kg
Seat Hinge Material	Stainless Steel
Antibacterial Protection	No
Seat Type	Slim
UV Protection	-
Max Load Test	150kg
Seat Material	Thermoset

Pan Specification

Comfort Height Rimless Closed Back Close Coupled Pan
(INST01042)

Finish	White
Dimensions	460(h) x 365(w) x 640(d) mm
Weight	35.3kg
Fixing Supplied	Yes
Fixing Exposed or Concealed	Exposed







Spares

Please see next page

FAQs

Please see next page

Key Features + Benefits

10	5	2							
Years Guarantee on Ceramics	Years Guarantee on Seats	Years Guarantee on Cistern Components	Closed Back WC Suite	Close Coupled WC Suite	Comfort Height Pan	Rimless Pan	4.5 Ltr 3 Ltr Dual Flush Volume	Air Gap Inlet Valve	Soft Close Seat

Certifications + Approvals

Roper Rhodes

Brassmill Lane Trading Estate, Bath, BA1 3JF. Technical Support – Tel: 01225 303 900 Email: sales@roperrhodes.co.uk

All information on the data sheet is correct at the time of publication. All measurements are approximate and subject to standard tolerances.

Espada Comfort Height Rimless Closed Back Close Coupled WC Suite INST01042, INST01009, INST01011

Pan (INST01042) + Cistern (INST01009)

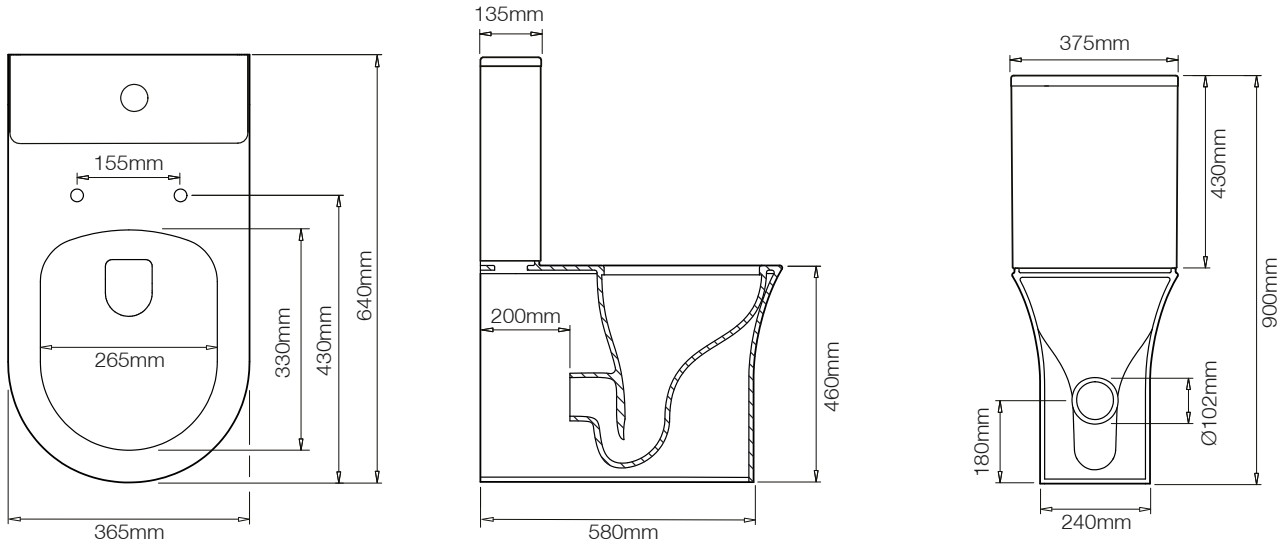

Seat (INST01011)

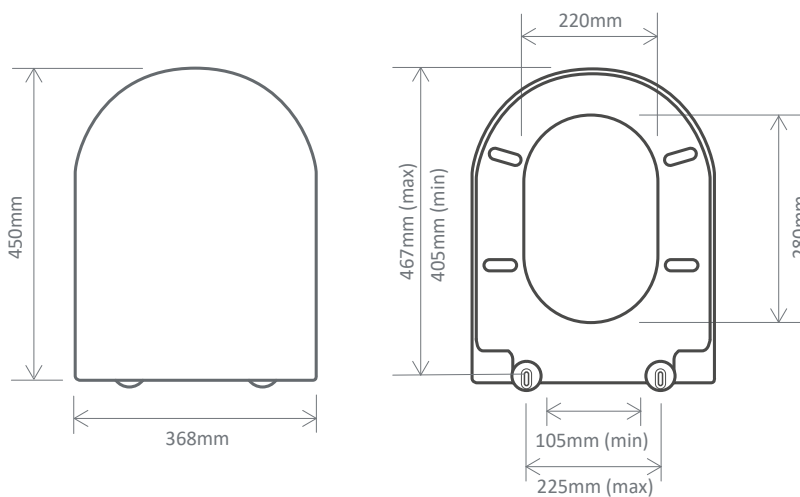

Extra Dimensions

Seat/Lid Front to Back – 450mm
Seat/Lid Left to Right – 368mm
Ring Hole Front to Back – 280mm
Ring Hole Left to Right – 220mm

Seat Overall Thickness – N/A
Width of Back of Seat – N/A
Min/Max Adjustment for Fixings –
105/225, 405/467mm

Spares

Floor Fixing Kit SP11078

Cistern Fittings SPT133
(Non Air Gap Inlet Valve)

Flush Valve with Telescopic Overflow (A24232) INST02043

Rubber Flap Seal SP19617
(For A24232 Flush Valve)

Air Gap Inlet Valve (Tall) SP19528

Rubber Diaphragm SP19616
(Air Gap Inlet Valve)

Close Coupled Cistern SP19538
Foam Gasket / Donut Washer (Ø90mm)

Brass Tank Fixing Bolt Set SP19542
(With M6*80mm Bolts)

Flush Valve Flow Reducer SP19707
(Ø45mm)

Chrome Flush Button SP19532
(Ø38mm Hole)

Black Flush Button INST02036
(Ø38mm Hole)

Brushed Brass Flush Button INST02044
(Ø38mm Hole)

Roper Rhodes

Brassmill Lane Trading Estate, Bath, BA1 3JF. Technical Support – Tel: 01225 303 900 Email: sales@roperrhodes.co.uk

All information on the data sheet is correct at the time of publication. All measurements are approximate and subject to standard tolerances.

Espada Comfort Height Rimless Closed Back Close Coupled WC Suite INST01042, INST01009, INST01011

FAQs

Q – What side is the inlet located?

A – Left hand side.

Q – Can this pan be used with a side connection outlet pipe?

A – No.

Q – The cistern lid won't shut/the cistern isn't working correctly?

A – Ensure the inlet and flush valves are set to the correct heights.

Q – What is the flush volume?

A – 4.5/3L.

Q – Is this WC rimless or box rim?

A – Rimless.

Q – Does it have an airgap?

A – Yes.

Q – Are there any other compatible seats?

A – Yes, INST01023 Wrap-Over seat.

Q – What's the maximum test load of the seat?

A – 150kg.

Q – What are the fixings made from?

A – Chrome Plated Stainless Steel.