

Espada Aluminium 450 x 1200mm Double Panel Horizontal Radiator (Heating Only)

ESAL-HDP04401200WH



Specification

Finish	White
Dimensions	440(h) x 1200(w) x 122(d) mm
Weight	10.5kg
BTU Output/Hr	5163
Watts @ $\Delta T50^{\circ}C$	1513
Bars	8
Pipe Centres	1150mm
Electric Element Wattage	-
End to End Connections	-
Radiator Columns	-
Material	Aluminium

All heat outputs are shown at $50^{\circ}C \Delta t$ in compliance with BSEN442. Watts and Btu's apply to Heating and Dual Fuel only.

Key Features + Benefits



Certifications + Approvals

Espada Aluminium 450 x 1200mm Double Panel Horizontal Radiator (Heating Only) ESAL-HDP04401200WH

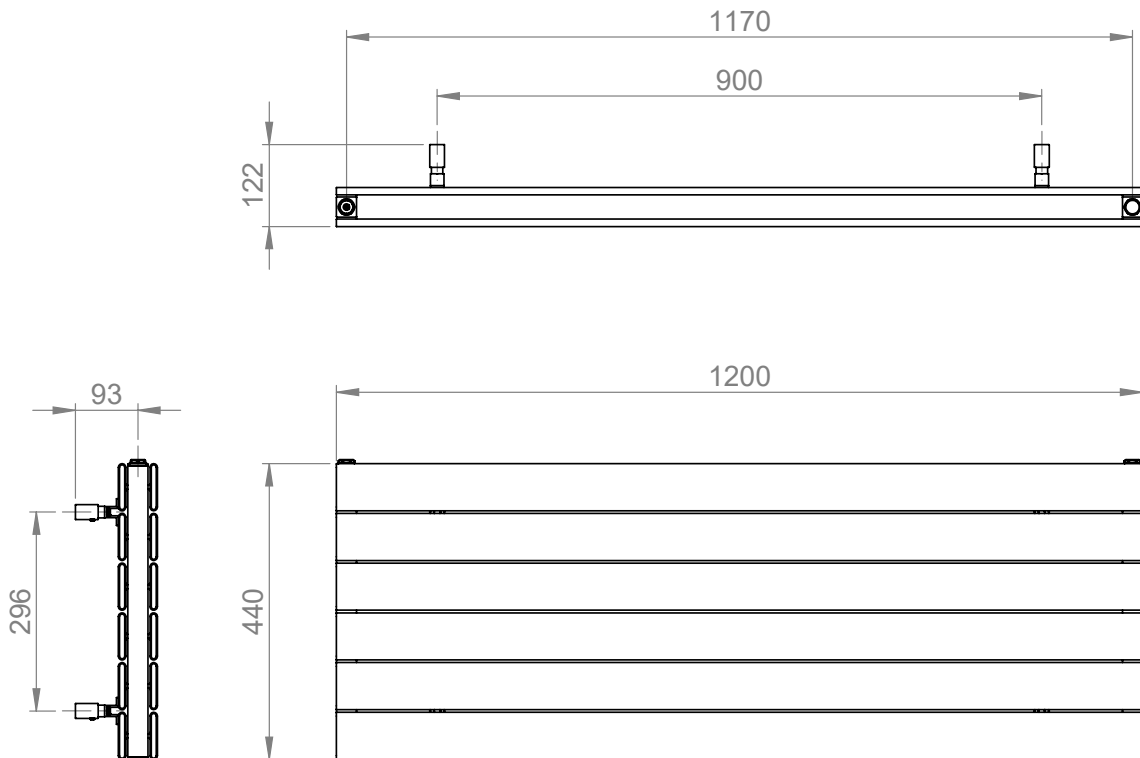

*Dual energy models require a conversion-tee, consult relevant drawing for details.