

INSTINCT®

INST03014-SF

BEFORE STARTING

Please read carefully before attempting to fit the seat & refer to the 'does it fit' diagram below to ensure it's suitable for your toilet before removing packaging. Please make sure the warnings and after-care instructions are made available for the end user to read.

Does it fit?

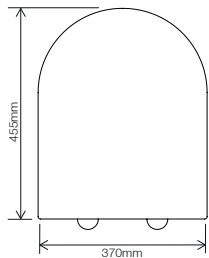

Overall seat dimensions

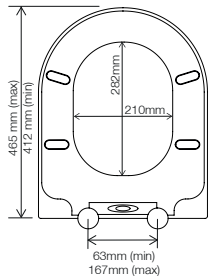

Max/min fixing adjustment

Top Fix Installation

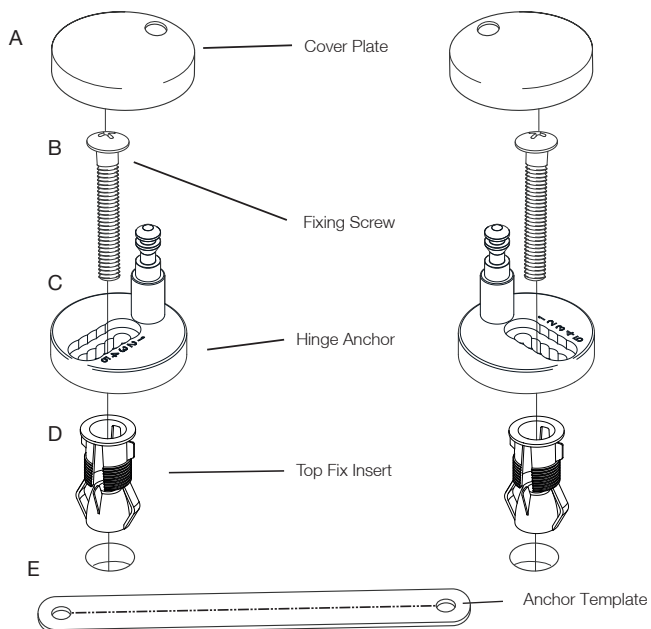

Note - alternative nuts and washers are supplied if you wish to secure the seat from underneath the deck of the toilet pan. If so dispose of the top fix inserts and tighten with the fixing key supplied.

Fitting Instructions

- 1 Push top fix inserts into toilet pan holes.

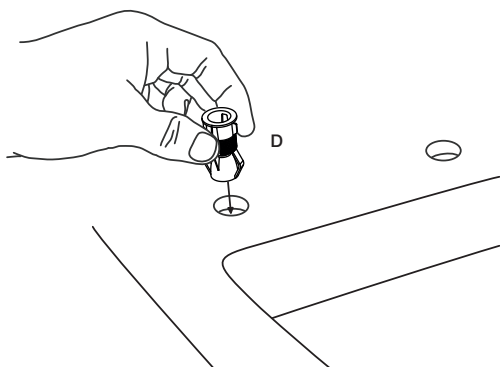

- 2 Place the template over the anchor pins, selecting the appropriate hole numbers (on the anchors) so that the 438mm dimension from the front of the pan to the centre line of the template is met.

Note: Selected anchor numbers must be matching

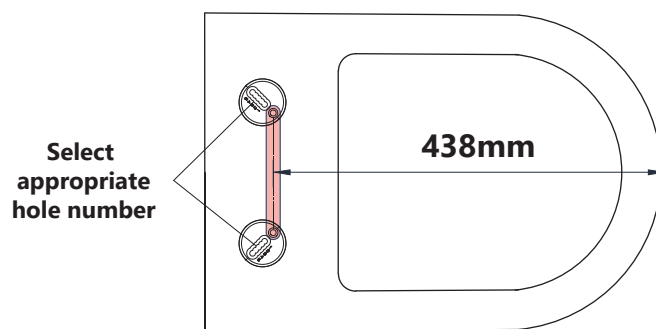

- 3 Once the 438mm dimension shown above is met and the template is parallel to the back edge, insert the bolts then tighten using a screw driver.



Secure as tightly as possible by hand. Do NOT use a battery drill or driver.

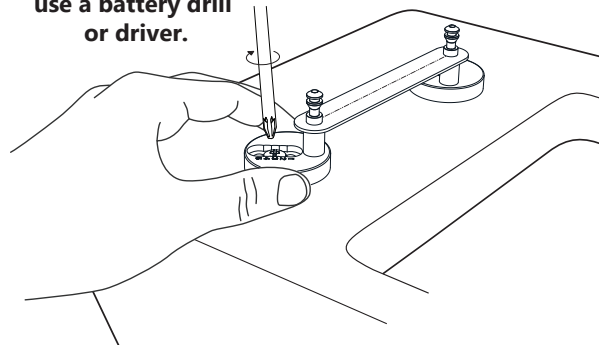

- 4 Remeasure the distance, making sure the 438mm dimension is met and remove the template and add the cover cap.

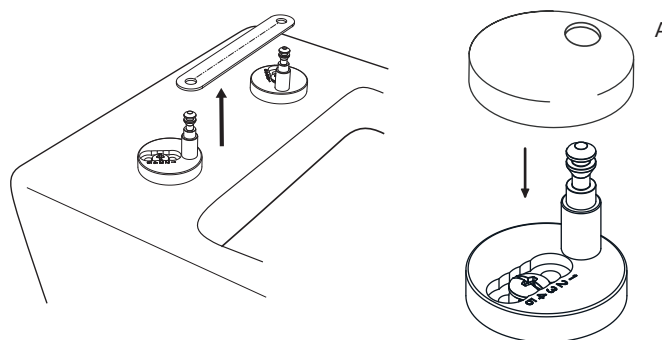

- 5 Click seat in place.

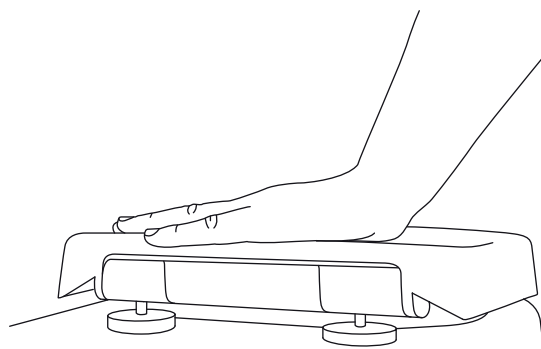

Under Fix Installation

- Place the template over the anchor pins, selecting the appropriate hole numbers (on the anchors) so that the 438mm dimension from the front of the pan to the centre line of the template is met.

Note: Selected anchor numbers must be matching

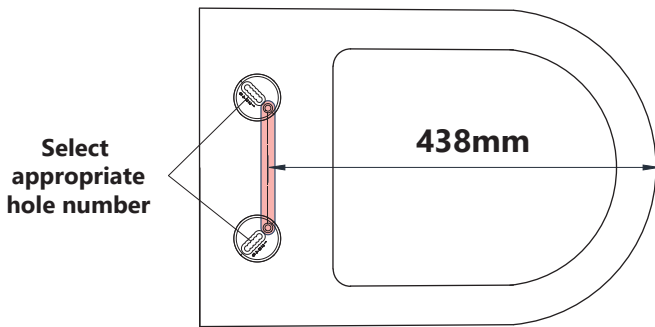

- Once the 438mm dimension shown above is met and the template is parallel to the back edge, insert the bolts and tighten the underfix components, then tighten using a screw driver.



Secure as tightly as possible by hand. Do NOT use a battery drill or driver.

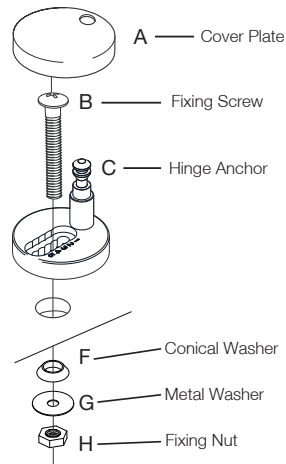
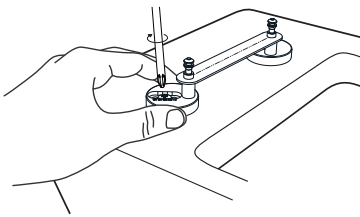

- Remeasure the distance, making sure the 438mm dimension is met and remove the template and add the cover cap.

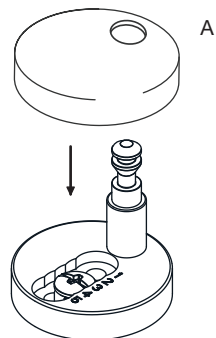
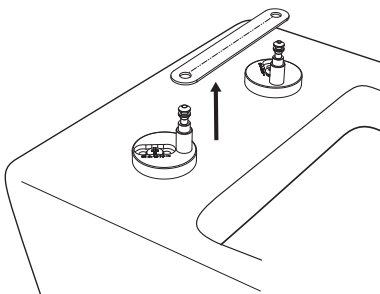

- Click seat in place.

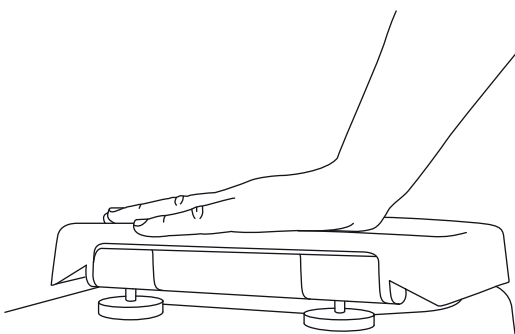

WARNINGS

- The fittings pack contains small items which should be kept away from young children.
- The toilet seat can be dangerous if incorrectly installed. Assembly should be carried out by a competent person. No liability will be accepted for damage or injury caused by incorrect product installation or assembly.
- Do not stand on the lid or ring of your toilet seat.
- After a few days check that the fixings are still tight. This is necessary as the rubber components will compress during the first few days.
- Periodically check all fixings to ensure none have come loose and re-tighten where necessary. Please take care when handling or moving the toilet seat as careless handling may cause damage or injury.
- Never over rotate the seat open when it is removed from the WC as this can cause damage to the hinges.
- Do not force down the seat ring or lid as this may compromise the performance of the soft close hinges.

AFTERCARE INSTRUCTIONS

Removing seat for cleaning

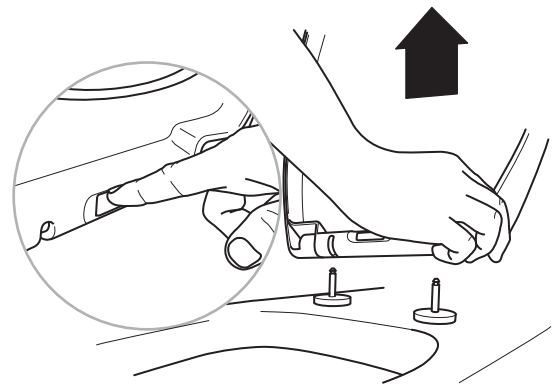

Clean surfaces with a soft damp cloth and mild soap solution



Do not scrub or scour



Do not use abrasive cleaning agents. If using bleach, abrasive or corrosive cleaning agents inside the toilet bowl, ensure that these do not come into contact with the seat. Keep the seat in the upright position until all cleaner has been flushed away.



Do not stand on the lid or ring of your toilet seat

For Technical Help Call:
01225 303 900

Customer Services | Brassmill Lane Trading Estate | Bath | BA1 3JF
Fax: 01225 448877