

Darton 748 x 498mm Towel Rail (Dual Fuel) DA750MB-HE



Specification

Finish	Matt Black
Dimensions	748(h) x 498(w) x 124(d) mm
Weight	8.06kg
BTU Output/Hr	635
Watts @ Δ T50°C	186
Bars	4
Pipe Centres	-
Electric Element Wattage	100
Face to Face Connections	-
Air Vent Position	-
Material	Mild Steel

All heat outputs are shown at 50°C Δ t in compliance with BSEN442. Watts and Btu's apply to Heating and Dual Fuel only.

Key Features + Benefits

15	MS	DF
Years Guarantee	Mild Steel	Dual Fuel

Certifications + Approvals

Technical Data Sheet | Designer Towel Rails

Darton 748 x 498mm Towel Rail (Dual Fuel) DA750MB-HE

Vertical Connection

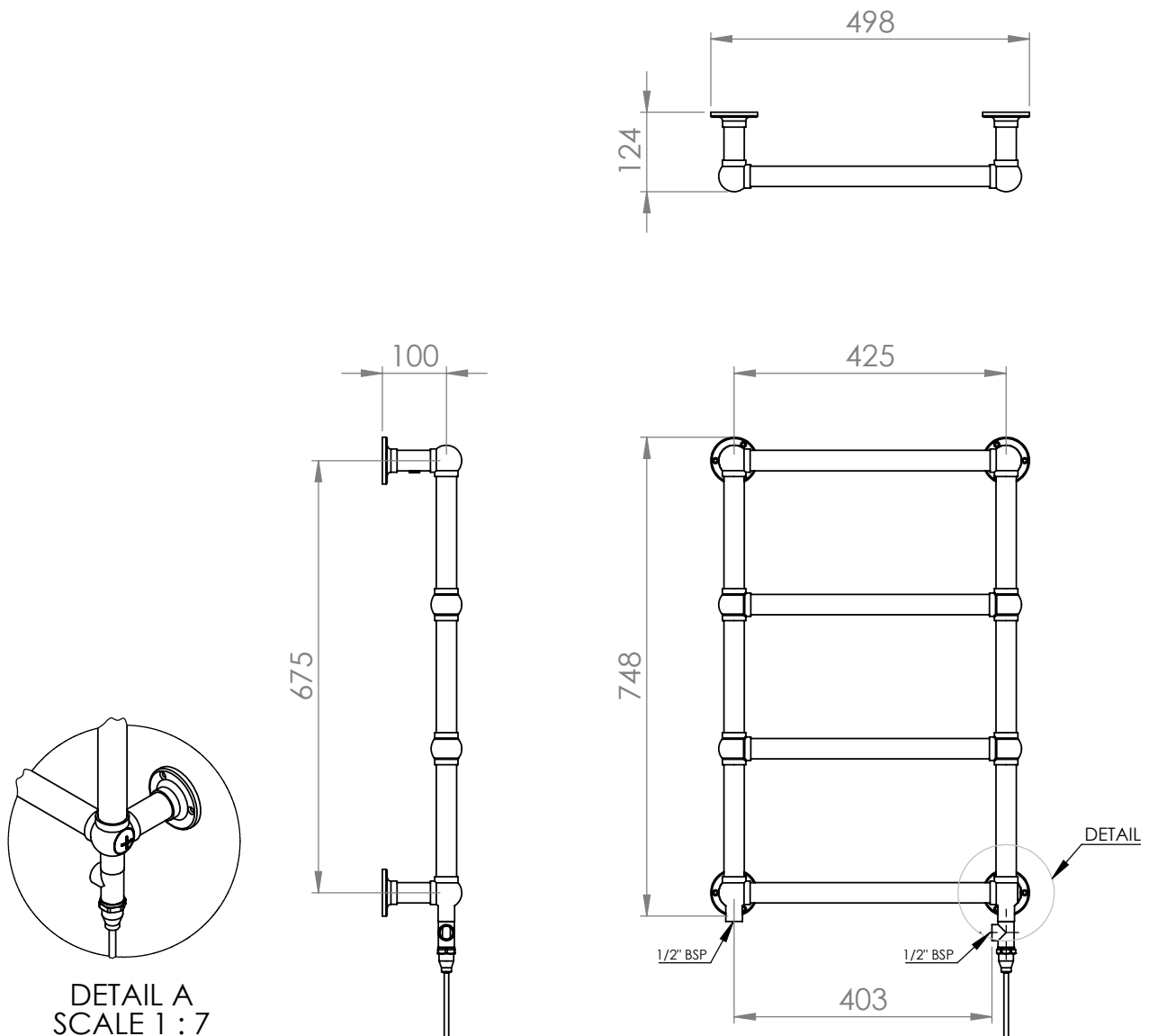

*Dual energy models require a conversion-tee, consult relevant drawing for details.

Technical Data Sheet | Designer Towel Rails

Darton 748 x 498mm Towel Rail (Dual Fuel) DA750MB-HE

Horizontal Connection

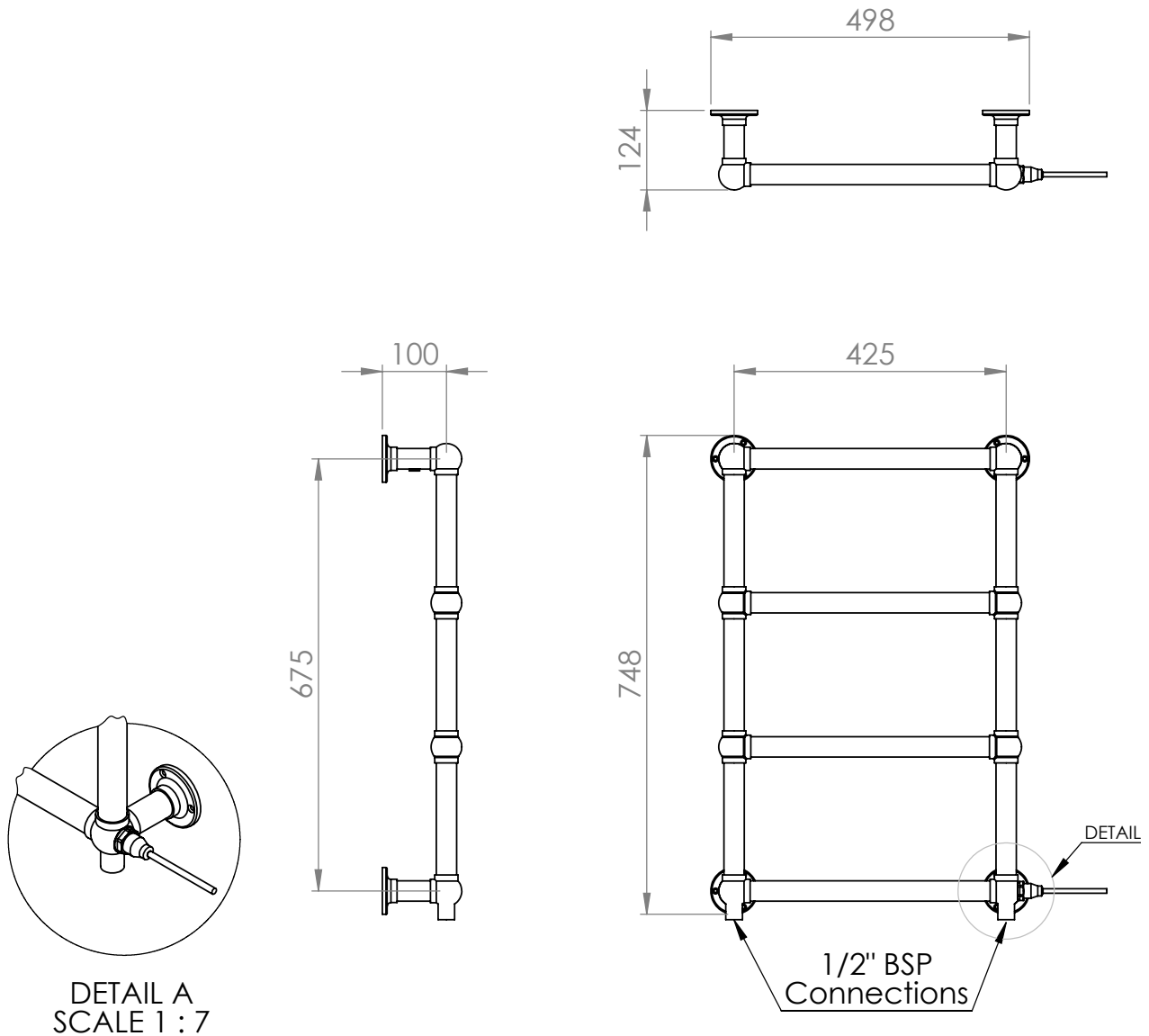

*Dual energy models require a conversion-tee, consult relevant drawing for details.