

Darton 748 x 498mm Towel Rail (Heating Only) DA750BB

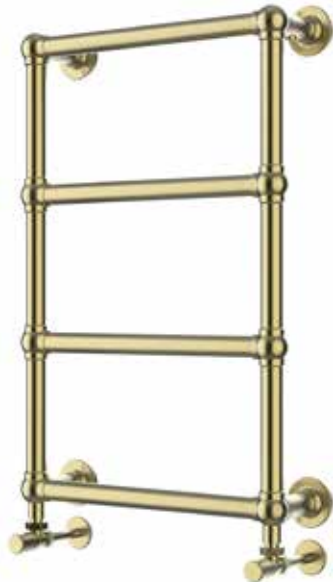

Specification

Finish	Brushed Brass
Dimensions	748(h) x 498(w) x 130(d) mm
Weight	7.06kg
BTU Output/Hr	584
Watts @ Δ T50°C	171
Bars	4
Pipe Centres	425
Electric Element Wattage	–
Face to Face Connections	–
Air Vent Position	–
Material	Mild Steel

All heat outputs are shown at 50°C Δ t in compliance with BSEN442. Watts and Btu's apply to Heating and Dual Fuel only.

Key Features + Benefits

15	MS	H
Years Guarantee	Mild Steel	Heating Only

Certifications + Approvals

Technical Data Sheet | Designer Towel Rails

Darton 748 x 498mm Towel Rail (Heating Only) DA750BB

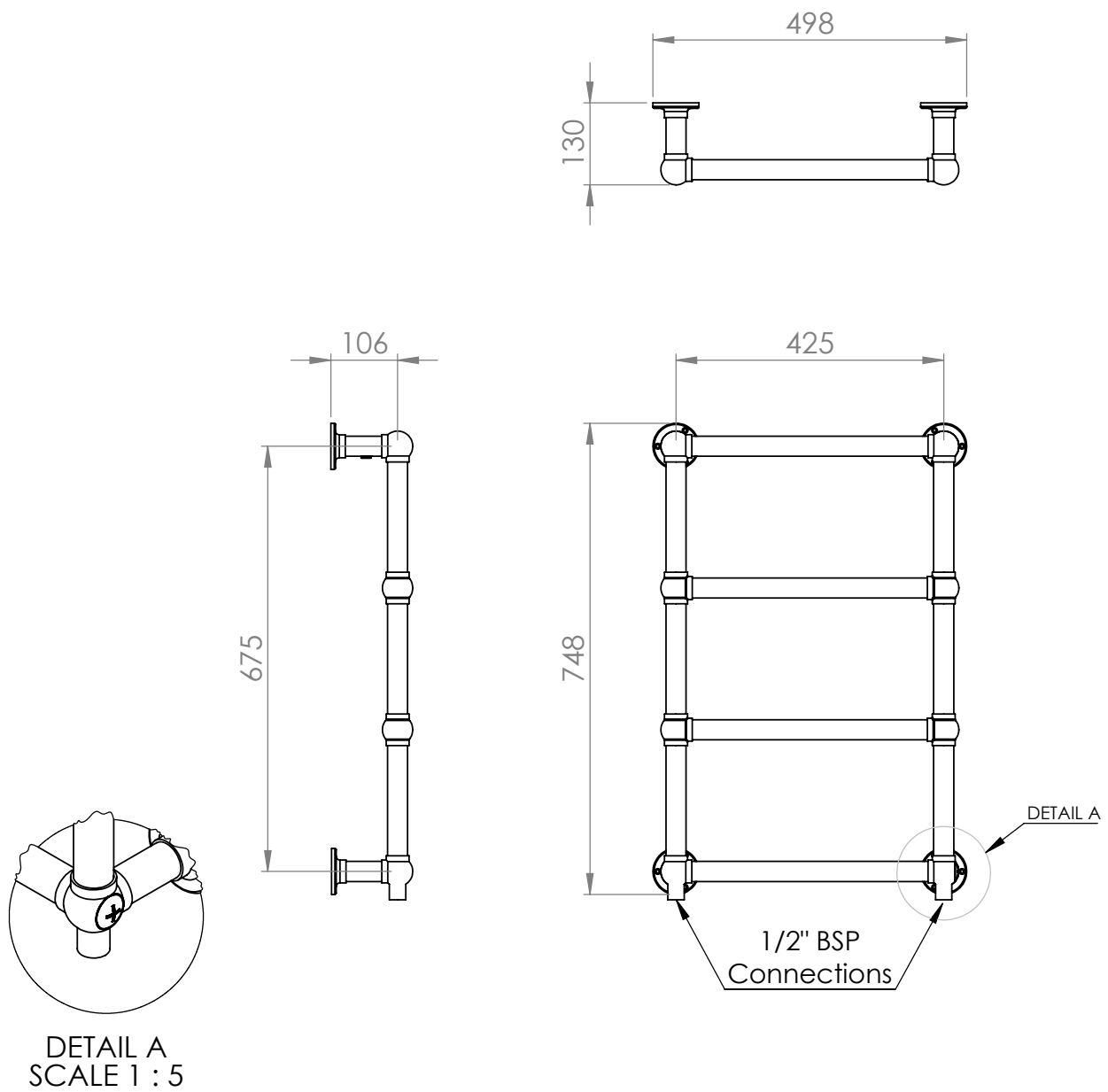

*Dual energy models require a conversion-tee, consult relevant drawing for details.