

Darton 1193 x 498mm Towel Rail (Heating Only) DA1195MB



Specification

Finish	Matt Black
Dimensions	1193(h) x 498(w) x 125(d) mm
Weight	10.26kg
BTU Output/Hr	1096
Watts @ Δ T50°C	321
Bars	5
Pipe Centres	425
Electric Element Wattage	–
Face to Face Connections	–
Air Vent Position	–
Material	Mild Steel

All heat outputs are shown at 50°C Δ t in compliance with BSEN442. Watts and Btu's apply to Heating and Dual Fuel only.

Key Features + Benefits

15	MS	H
Years Guarantee	Mild Steel	Heating Only

Certifications + Approvals

Technical Data Sheet | Designer Towel Rails

Darton 1193 x 498mm Towel Rail (Heating Only) DA1195MB

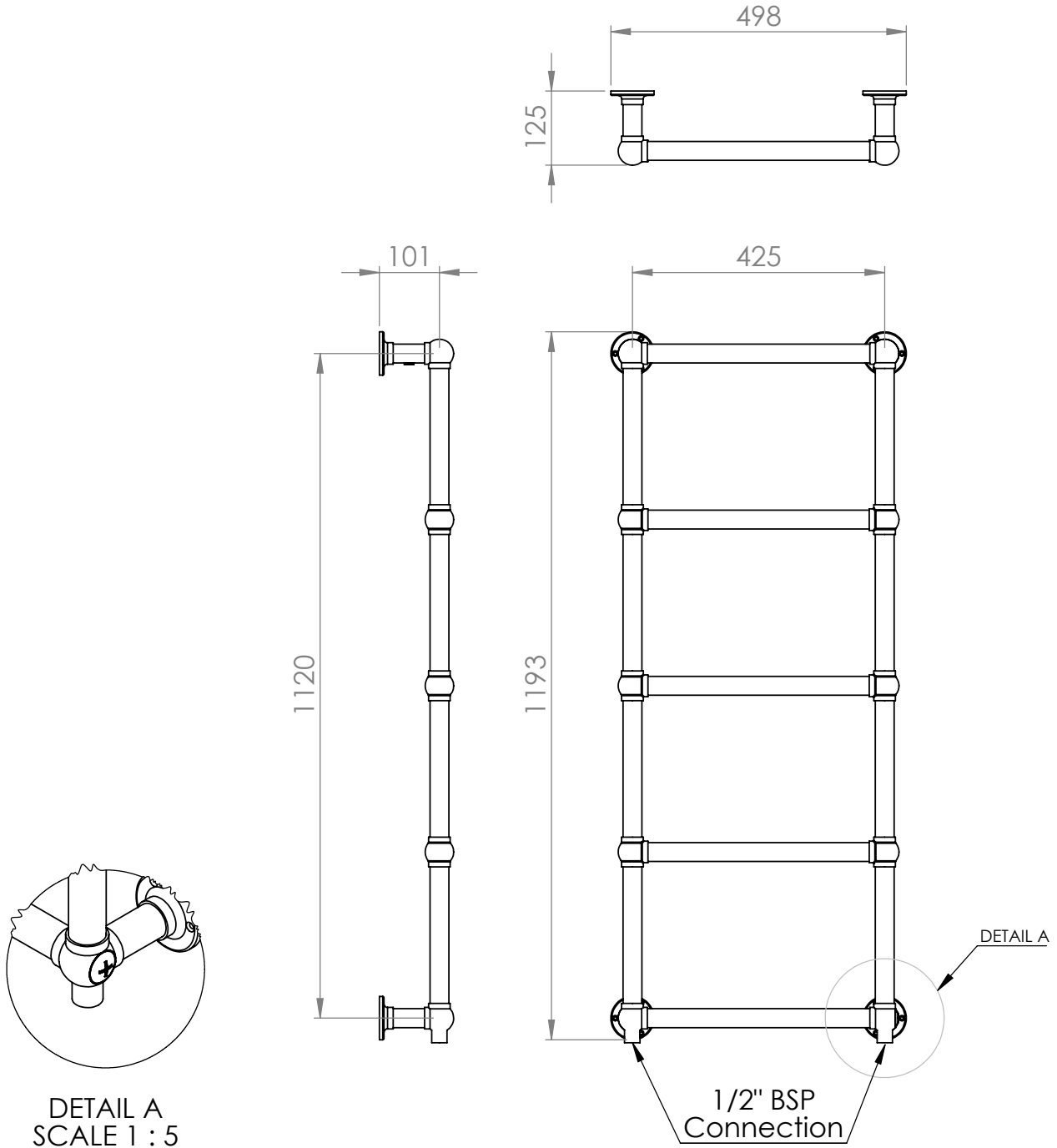

*Dual energy models require a conversion-tee, consult relevant drawing for details.