

Adore 750 x 636mm 4 Column Radiator AD4C-075-14-0636



Specification

Finish	White
Dimensions	750(h) x 636(w) x 140(d) mm
Weight	31kg
BTU Output/Hr	4835
Watts @ Δ T50°C	1417
Bars	14
Pipe Centres	–
Electric Element Wattage	–
End to End Connections	636mm
Radiator Columns	4
Material	Mild Steel

All heat outputs are shown at 50°C Δ t in compliance with BSEN442. Watts and Btu's apply to Heating and Dual Fuel only.

Key Features + Benefits



Certifications + Approvals

Adore 750 x 636mm 4 Column Radiator AD4C-075-14-0636

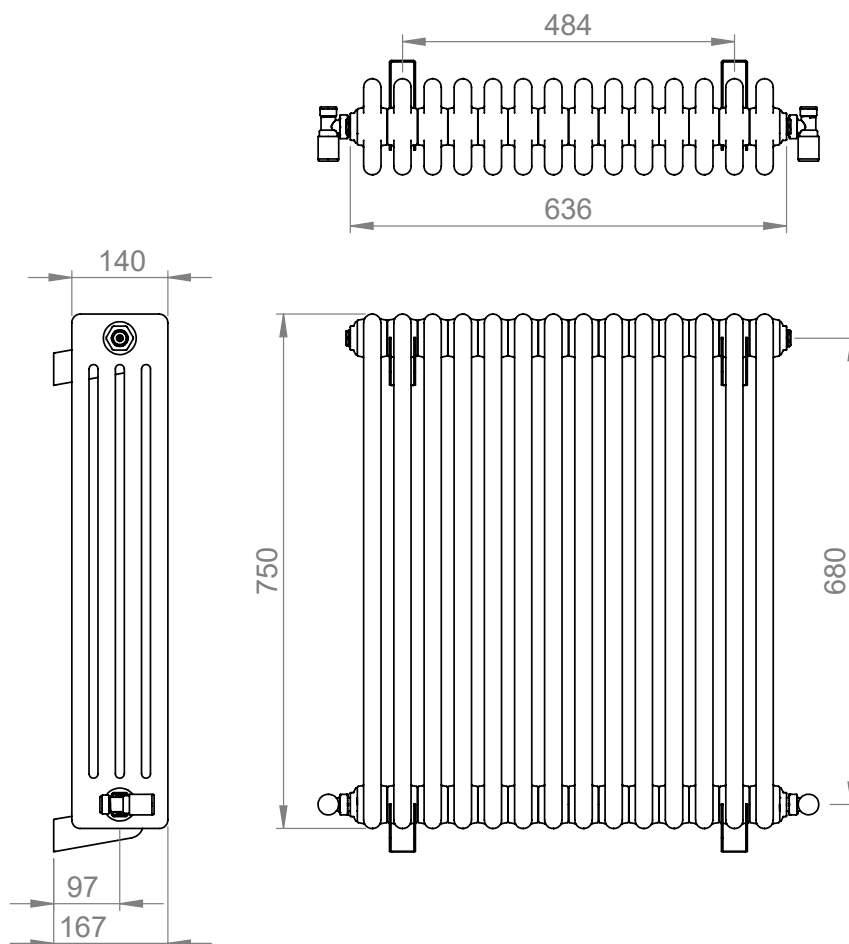

*Dual energy models require a conversion-tee, consult relevant drawing for details.