

### Adore 600 x 636mm 4 Column Radiator AD4C-060-14-0636



#### Specification

Finish	White
Dimensions	600(h) x 636(w) x 140(d) mm
Weight	24kg
BTU Output/Hr	3914
Watts @ $\Delta$ T50°C	1147
Bars	14
Pipe Centres	–
Electric Element Wattage	–
End to End Connections	636mm
Radiator Columns	4
Material	Mild Steel

All heat outputs are shown at 50°C  $\Delta$ t in compliance with BSEN442. Watts and Btu's apply to Heating and Dual Fuel only.

#### Key Features + Benefits



#### Certifications + Approvals

## Technical Data Sheet | Designer Radiators

### Adore 600 x 636mm 4 Column Radiator AD4C-060-14-0636

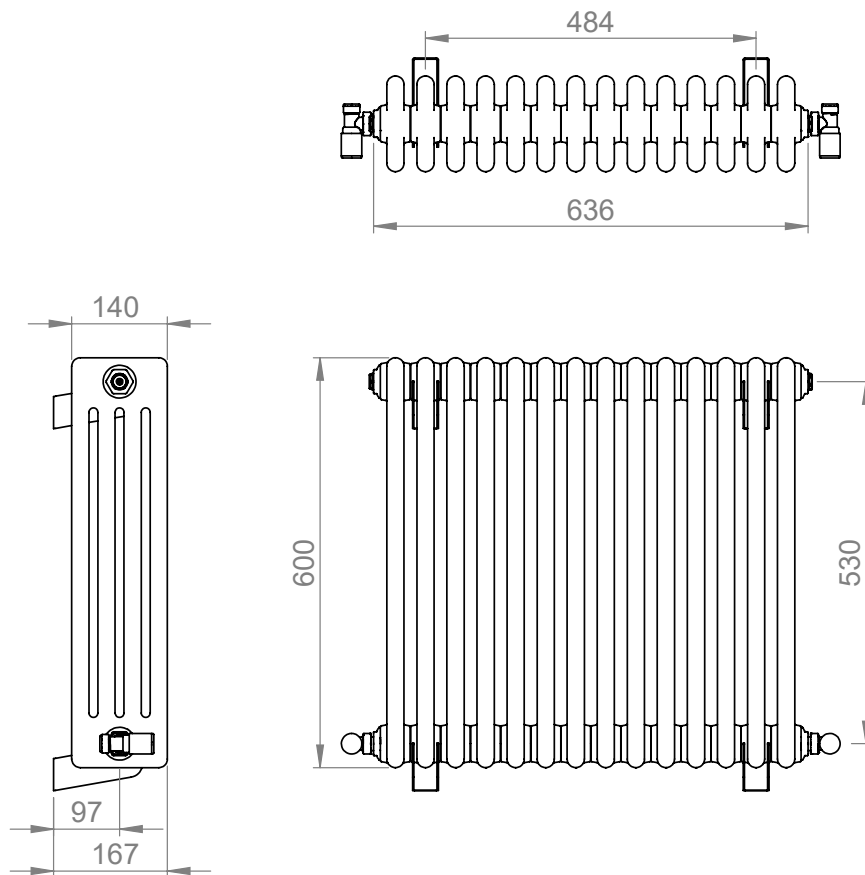

\*Dual energy models require a conversion-tee, consult relevant drawing for details.