

Adore 750 x 636mm 3 Column Radiator AD3C-075-14-0636



Specification

Finish	White
Dimensions	750(h) x 636(w) x 100(d) mm
Weight	17kg
BTU Output/Hr	3583
Watts @ Δ T50°C	1050
Bars	14
Pipe Centres	–
Electric Element Wattage	–
End to End Connections	636mm
Radiator Columns	3
Material	Mild Steel

All heat outputs are shown at 50°C Δ t in compliance with BSEN442. Watts and Btu's apply to Heating and Dual Fuel only.

Key Features + Benefits



Certifications + Approvals

Technical Data Sheet | Designer Radiators

Adore 750 x 636mm 3 Column Radiator AD3C-075-14-0636

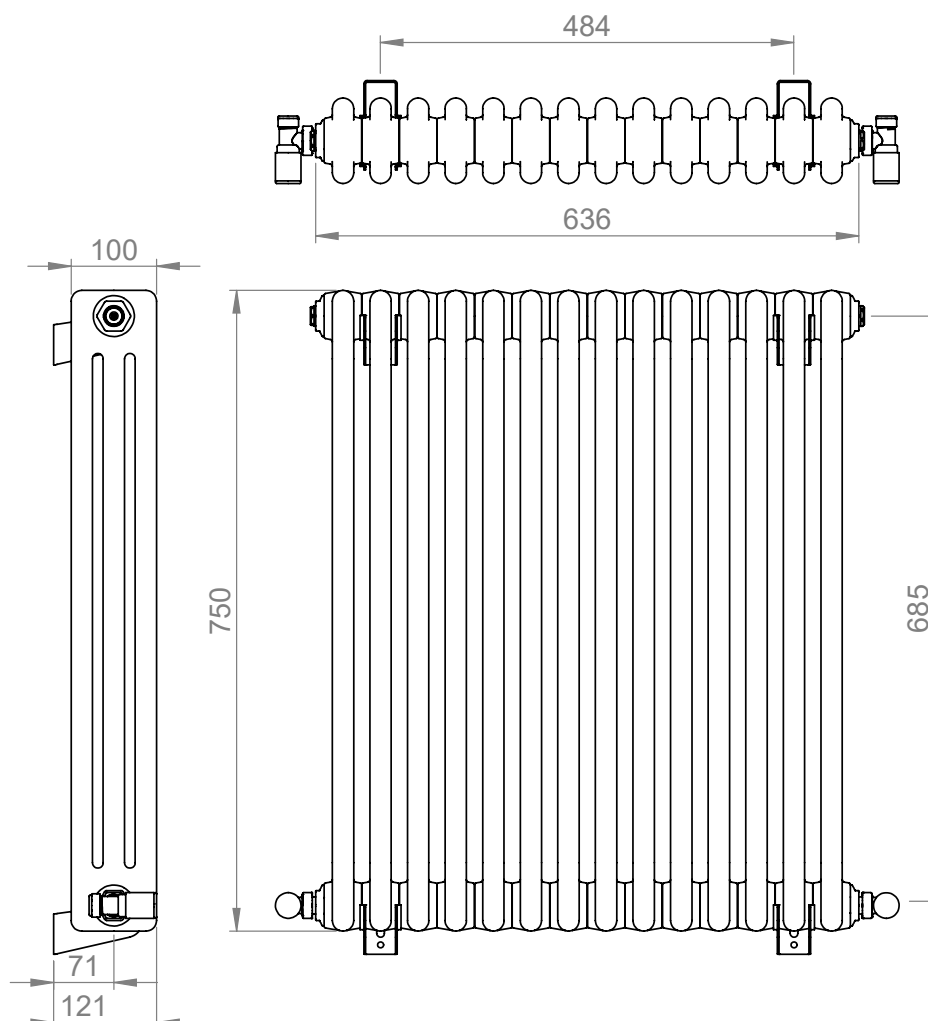

*Dual energy models require a conversion-tee, consult relevant drawing for details.