

Adore 600 x 812mm 2 Column Radiator AD2C-060-18-0812



Specification

Finish	White
Dimensions	600(h) x 812(w) x 68(d) mm
Weight	15kg
BTU Output/Hr	2702
Watts @ Δ T50°C	792
Bars	18
Pipe Centres	–
Electric Element Wattage	–
End to End Connections	812mm
Radiator Columns	2
Material	Mild Steel

All heat outputs are shown at 50°C Δ t in compliance with BSEN442. Watts and Btu's apply to Heating and Dual Fuel only.

Key Features + Benefits



Certifications + Approvals

Adore 600 x 812mm 2 Column Radiator AD2C-060-18-0812

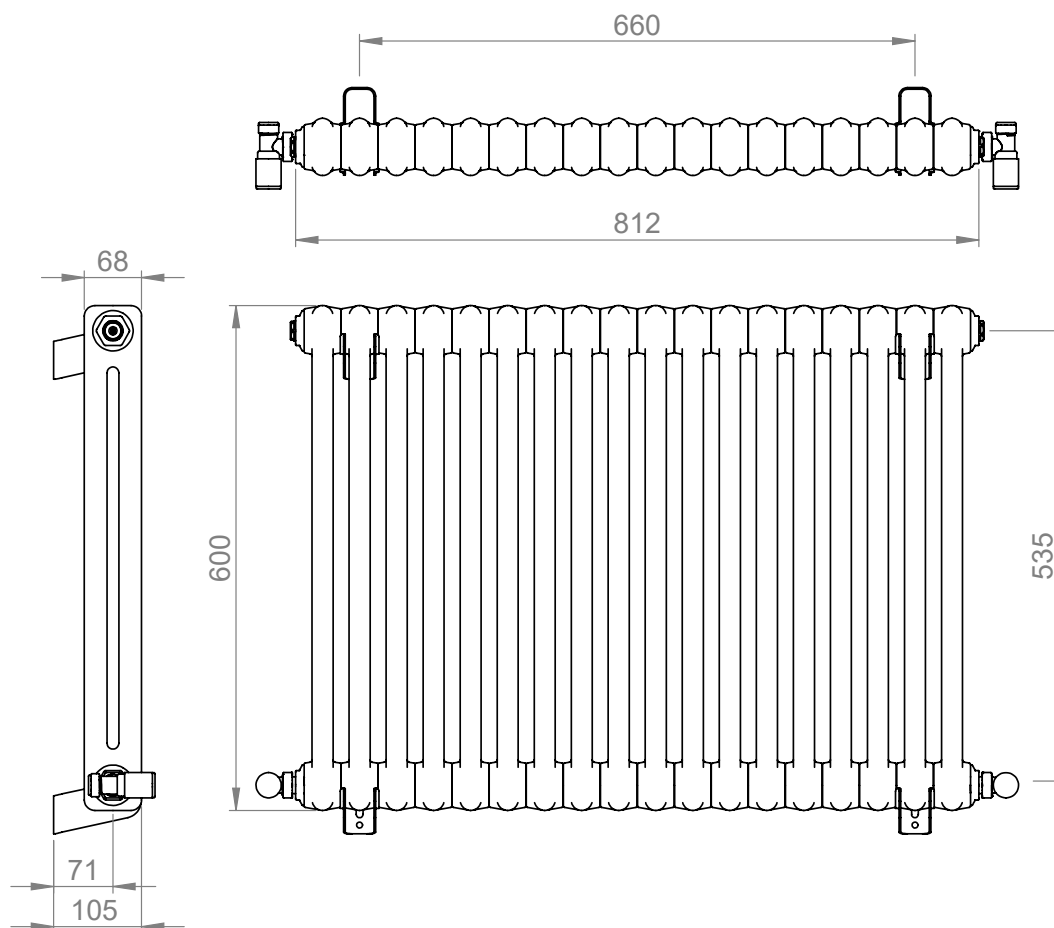

*Dual energy models require a conversion-tee, consult relevant drawing for details.